	<input type="checkbox"/> Policy Directive <input type="checkbox"/> Procedural Directive <input checked="" type="checkbox"/> Guideline	Number: 4
Title: Building in Close Proximity to Existing Light Rail Tracks	Supersedes: Informal plan reviews	

1. Purpose and Scope:

The Engineering Division has responded to enquiries from development groups and cities, attended meetings, and reviewed plans regarding proposed developments adjacent to RTD’s light rail system. While most meetings, conversations, and emails touch upon some of the issues, others are not addressed. This document lists the major issues of building and operating next to an active light rail track.

RTD has a design criteria document that governs the design of its Light Rail System. Electronic copies of the criteria will be provided on request. Contact Engineering@RTD-Denver.com for questions related to this document.

2. Implementation:

Track and systems planning, design, construction, and operation require precautions that developers, design professionals, contractors, and other agencies need to understand. Engineering Division staff can distribute copies of this document to raise awareness.

3. Planning and Design

- A. Sight distance is extremely important for the train operator and for the safety of the general public. Trains need a significant distance to stop, once brakes are applied. A train traveling at 20 miles per hour (mph) requires approximately 230 feet to come to a complete stop. For a pedestrian crossing the tracks, the train operator needs about 5 seconds and 100 feet at 20 mph, once the pedestrian steps off the curb, to slow the train to allow the pedestrian to cross safely. Higher speeds require additional time and distances. Having a clear line of sight is therefore extremely important. To obtain this line of sight:
 - 1. Avoid creating visual obstructions for the train driver.
 - 2. Keep landscaping below 12-18-inches.
 - 3. Wherever practicable, all posts, pipes, signs, bollards, markers, and other small obstructions should be given a side clearance of at least 10 feet measured from track centerline and meet standards of the local jurisdiction, AASHTO and MUTCD.
 - 4. Minimize locations where people can accidentally fall onto the track. Do not place benches and seating areas close to the track.
 - 5. Encourage pedestrian crossing movements to be at intersections.

	<input type="checkbox"/> Policy Directive <input type="checkbox"/> Procedural Directive <input checked="" type="checkbox"/> Guideline	Number: 4
Title: Building in Close Proximity to Existing Light Rail Tracks	Supersedes: Informal plan reviews	

- B. Maintaining the safety of the system is very important as well as creating an environment which benefits both the public and operations of the transit system. Designing elements in and around the trackway should therefore take this into consideration.
1. In emergency situations, the train may need to stop anywhere on the track, open its doors, and let out people on the adjacent sidewalks and roadways.
 2. Minimize trip hazards on adjacent sidewalks.
 3. Avoid creating restricted areas where people could get pinned between the train and an obstruction of the sidewalk. A minimum setback of 10 feet from the center line of track is strongly recommended for all elements placed adjacent to the trackway.
 4. Station platforms and sidewalks adjacent to platforms, where waiting areas and platform areas merge, should preferably have a width of 12 feet to accommodate accessible highblocks, waiting area for passengers, and to allow for free flow of pedestrian movement. Each location should be evaluated depending on projected use of the area.
 5. Breakaway units shall be used where the installation is in a location exposed to traffic.
 6. Snow removal shall be considered in the design of facilities so as to not impede pedestrian flow, vehicular traffic and train operations.
 7. The train system generates vibration and noise. Owners of adjacent properties should take these factors into account.
- C. Train operations also require the integrity of the trackway be maintained at all times. The trackway and the catenary system (the overhead electrical system) needs to have a clear pathway in which to operate. The catenary system may sway. The dynamic envelope of the train generally requires 6 feet 2 inches clear horizontally from centerline of track, in order not to hit an obstruction in the path of the train. At locations where the train follows a curve, additional clearance is required. Determining the dynamic envelope in these instances will require additional analysis. The trackway itself needs a stable foundation on which to be placed so as not to shift and therefore have the potential for the train to derail or leave the trackway. Therefore:
1. No obstruction is permitted within the dynamic envelope of the train.

	<input type="checkbox"/> Policy Directive <input type="checkbox"/> Procedural Directive <input checked="" type="checkbox"/> Guideline	Number: 4
Title: Building in Close Proximity to Existing Light Rail Tracks	Supersedes: Informal plan reviews	

2. Tree canopies should be situated beyond 20-feet of the centerline of the track. It reduces the potential for the tree roots to undermine the trackway. It also reduces the danger from the need to prune or replace the tree, and keeps people and equipment needed to perform these activities from coming in contact with the overhead electrical system.
3. Excavation within the proximity of RTD tracks which encroaches into the supporting subgrade as described in the attached Figure 1, General Shoring Requirements, shall comply with the requirements of BNSF/UPRR Guidelines for Temporary Shoring. Live load for design of shoring adjacent to Light Rail tracks shall correspond to the attached RTD LRV Loading Diagram from the Light Rail Design Criteria. Contractor shall submit shoring plans and design calculations, stamped and signed by a Professional Engineer registered in the State of Colorado, to RTD for review and acceptance. The submittal shall include a stamped and signed cover letter stating that the shoring design complies with the BNSF/UPRR Guidelines for Temporary Shoring. Shoring design and plans shall be submitted no later than 60 days prior to planned start of construction. Construction adjacent to the tracks shall not begin prior to RTD acceptance of the shoring design.
4. RTD will review all proposed utilities across light rail tracks. Please see <http://www.rtd-denver.com/Reports.shtml> under the section "RTD Utility Agreements" for the process and requirements.
5. Open cutting for utility installation is not allowed across the light rail tracks because of the potential to undermine the track as well as creating an unsafe operating condition.
6. RTD cannot make any assurances to the horizontal location and cannot confirm depth to top or bottom of RTD duct banks between RTD tracks due to signal interference from track rails. The contractor shall identify the horizontal location and vertical depth of RTD underground electric and communication ducts without compromising the integrity of the RTD tracks or dynamic envelope. This may be accomplished by various means of locating the top and bottom of the RTD ducts as approved by RTD Engineering.
7. Existing contributory drainage areas and flows shall be maintained such that drainage to and /or across RTD LRT tracks is equal to or less that historic conditions.

	<input type="checkbox"/> Policy Directive <input type="checkbox"/> Procedural Directive <input checked="" type="checkbox"/> Guideline	Number: 4
Title: Building in Close Proximity to Existing Light Rail Tracks	Supersedes: Informal plan reviews	

8. The proposed development shall be designed to safely collect and convey historic flows from RTD's trackways and shall not construct obstructions that can divert additional flows into the trackway or create back water conditions for the trackway.
 9. The proposed development shall not discharge storm water directly into the trackway. All onsite drainage shall discharge into an approved storm drain system.
 10. The proposed development shall not discharge storm water drainage from adjacent property due to construction onto or across the tracks. Ballasted track in particular can lose its strength, if the ballast gets clogged with dirt.
 11. The proposed underground appurtenances shall not interfere with the continuity of the RTD underdrain system. All onsite dewatering systems shall be designed such that they do not surcharge the RTD underdrain system.
- D. Light Rail vehicles operate on a direct current (DC) electrical system. Stray DC current leaks are possible and therefore can create a corrosive environment near the trackway. For this reason, provide cathodic protection for buried metallic conduits and utilities near or crossing the tracks.
- E. Operation of the train may create electro-magnetic interference (EMI) to the surrounding area. Sensitive electronic equipment should therefore not be placed near the trackway. EMI generating type of equipment may also interfere with the train control system and therefore should be avoided near the train's signal control system which is normally part of the trackway.
- F. All metallic objects that are within 15 feet of the centerline of the near rail shall be grounded. Metallic objects should be connected to the ground grid if available or else a ground rod shall be driven. A minimal ground resistance test of 25 Ohms or less shall be achieved.
- G. Coordinate design and construction with RTD Operations, Engineering and Maintenance-of-Way. Early discussions and submittals are encouraged. Final Construction Plans need to be submitted a minimum of thirty days prior to construction. Complex projects may take longer to review.

	<input type="checkbox"/> Policy Directive <input type="checkbox"/> Procedural Directive <input checked="" type="checkbox"/> Guideline	Number: 4
Title: Building in Close Proximity to Existing Light Rail Tracks	Supersedes: Informal plan reviews	

12. Design Reviews

RTD Engineering shall review plans, and work with developers, design professionals, and other agencies to resolve comments and concerns.

13. Rail Right-of-Way Access

This shall apply to construction impacting RTD rail and/or within 25 feet of RTD tracks.

- A. Contractor shall be responsible for obtaining Maintenance-of-Way (MOW) light rail right of way access permit to perform work. The RTD light rail right of way access request permit can be found at: <http://www.rtd-denver.com/documents/rail-operations-access-permit.doc>

All personnel who shall be within 25-feet of the track shall undergo On Track Safety Training, prior to receiving the access permit.

- B. In order to receive an access permit to be in or work on the RTD alignment, a completed electronic access permit must be emailed to railopspermits@rtd-denver.com *no later than noon on the Wednesday prior* to the week the work will begin. When you submit a request, *attendance is also required* at the weekly Access Allocation meeting which will be held every Wednesday at 2:00 p.m. at the RTD Maintenance of Way Facility at 1350 Rio Court, Denver, CO 80204. If no representative attends the meeting, the request will not be approved.

- C. Contractor is responsible for providing and maintaining a written safety program conforming to the requirements of the RTD Construction Safety Manual. RTD's on-track safety training is required for all personnel performing work in the vicinity of light rail, commuter rail and freight rail systems. Contact Safety Compliance Officer at 303-299-2077 to schedule.

14. Construction Inspections



Contractor must contact RTD Engineering a minimum of 48 hours prior to start of construction to schedule a pre-construction meeting and arrange for on-site inspection during construction.

	<input type="checkbox"/> Policy Directive <input type="checkbox"/> Procedural Directive <input checked="" type="checkbox"/> Guideline	Number: 4
Title: Building in Close Proximity to Existing Light Rail Tracks	Supersedes: Informal plan reviews	

15. Construction Contracts

Based on the nature of proposed construction, RTD Risk Management may review construction contract coverages and limits, and require that RTD be named as an additional insured on policies.

16. Approval

Revision Level	Summary	Approved By	Signature	Date
0	Initial Baseline Issue	Jyotsna Vishwakarma, P.E. Acting Senior Manager Engineering / Chief Engineer		02/22/16
0	Initial Baseline Issue	Terry Emmons, Assistant General Manager, Rail Operations		2/22/16
0	Initial Baseline Issue	John F. Tarbert, Acting Assistant General Manager Safety, Security & Facilities		2-23-16

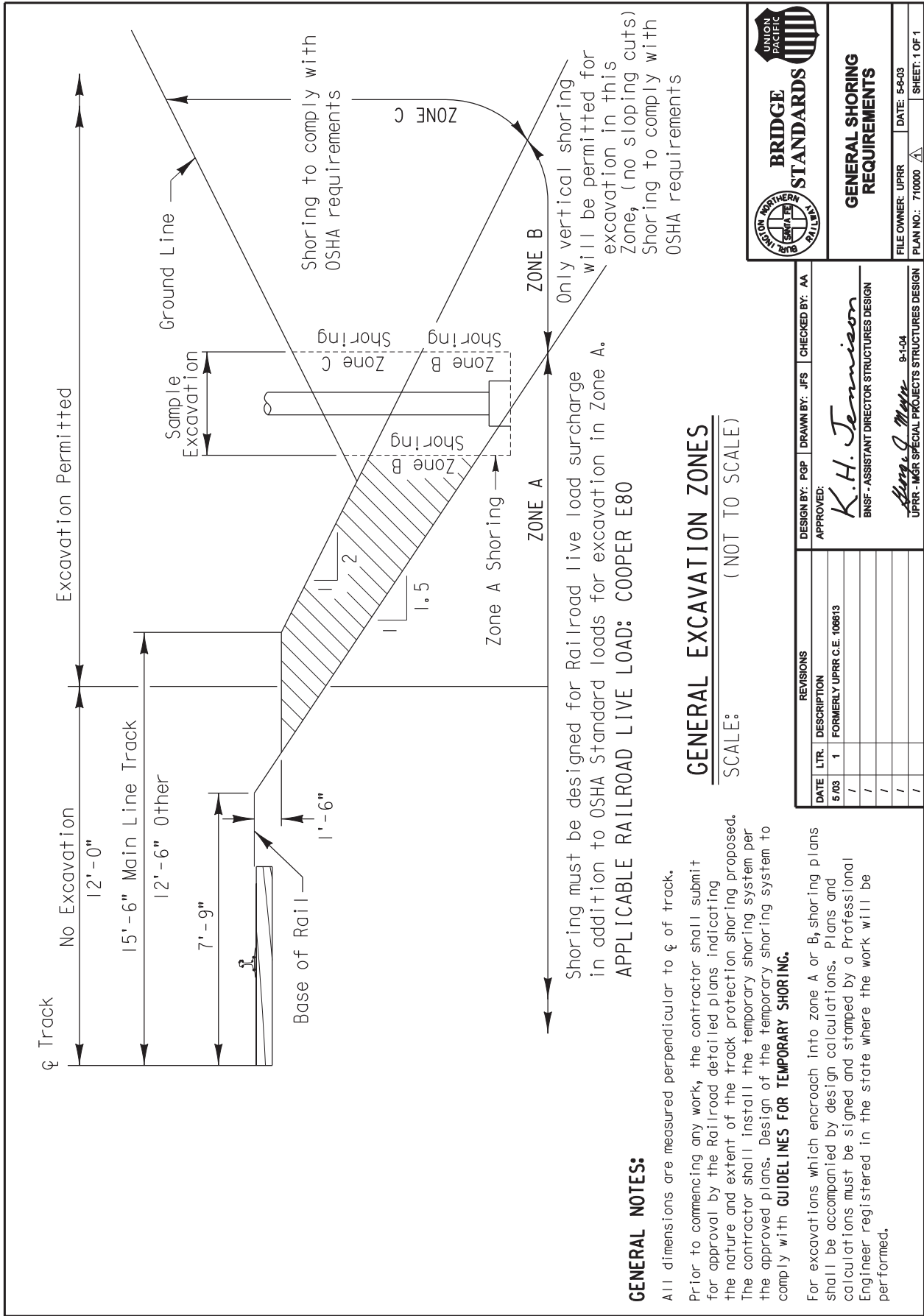

Figure 1

NOTE:

- 1. TOTAL CRUSH LOAD 130 KIPS/CAR
- 2. 1 to 4 CAR TRAINS SHALL BE CONSIDERED WHEN DETERMINING MAXIMUM STRUCTURAL RESPONSE

